

MANUAL CM-05

Li-ion battery powered tube motors
with pull and remote operation

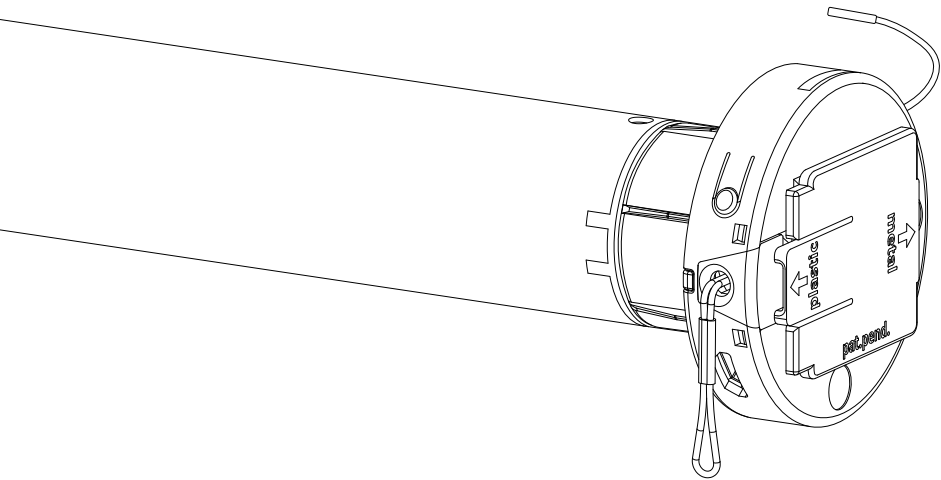

MOTION

CM-05

Li-ion battery powered tube motors with pull and remote operation

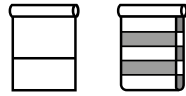

Motor features

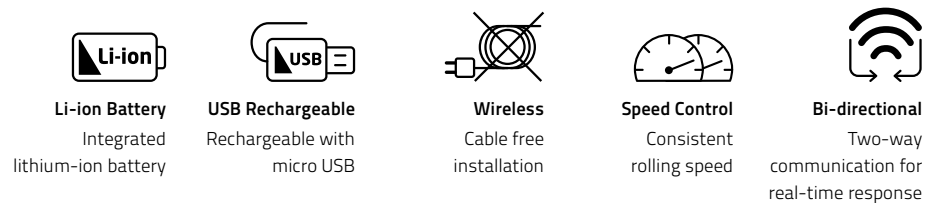

Li-ion Battery
Integrated lithium-ion battery

USB Rechargeable
Rechargeable with micro USB

Wireless
Cable free installation

Speed Control
Consistent rolling speed

Bi-directional
Two-way communication for real-time response

Control options

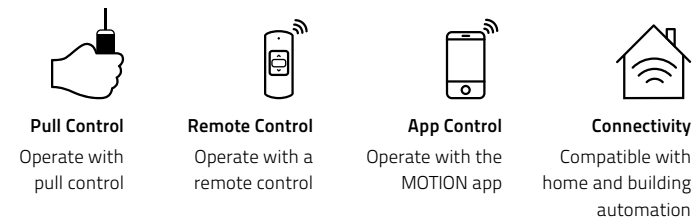

Pull Control
Operate with pull control

Remote Control
Operate with a remote control

App Control
Operate with the MOTION app

Connectivity
Compatible with home and building automation

Support



Video
How to install, program and operate
rtube.nl/red980



App Store
Download the MOTION app
rtube.nl/red981



Google Play
Download the MOTION app
rtube.nl/red982

WARNING

Read the instructions carefully before assembling and using the product. Assembly can be completed by non-professionals. For indoor use only.

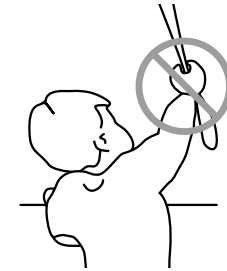

- Young children can strangle themselves with the loop of pull cords, chains and tapes, and cords that operate window coverings.
- To avoid strangulation and entanglement, keep cords out of reach of young children.
- Cords may ensnare a child's neck.
- Move beds, cots and furniture away from window covering cords.
- Do not tie cords together.
- Make sure cords do not twist together and form a loop.

Cleaning

Follow these general rules when cleaning the outside of the device and its components:

- Use a damp, soft, lint-free cloth. Avoid getting moisture in openings.
- Do not use aerosol sprays, solvents, alcohol, or abrasives.

Service & Support

Do not perform repairs yourself. Do not attempt to open the device or disassemble it. You run the risk of electric shock and voiding the limited warranty. No user-serviceable parts are inside.

Warranty Service

First follow the advice in this manual. If the product appears to be damaged or does not function properly, go to your local dealer for instructions on how to obtain warranty service.



Recycle

This marking indicates that this product should not be disposed with other household wastes throughout the EU. To prevent possible harm to the environment or human health from uncontrolled waste disposal, recycle it responsibly to promote the sustainable reuse of material resources. To return your used device, please use the return and collection systems or contact the retailer where the product was purchased. They can take this product for environmental safe recycling.

Important Safety instructions

WARNING: To reduce the risk of severe injury or death, it is important to follow these instructions for personal safety. Save these instructions.

- Read and follow all installation instructions.
- This appliance can be used by children aged 8 years and above and persons with reduced physical, sensory or mental capabilities or lack of experience and knowledge if they have been given supervision or instruction concerning use of the appliance in a safe way and understand the hazards involved. Children should not play with the appliance. Cleaning and user maintenance should not be performed by children without supervision.
- Do not allow children to play with fixed controls. Keep remote controls away from children.
- Frequently examine the installation for imbalance and signs of wear or damage to cables and springs. Do not use if repair or adjustment is necessary.
- This instruction manual is also available on the website.
- The drive must be disconnected from its power source during cleaning, maintenance and when replacing parts.
- The A-weighted emission sound pressure level of the drive is equal to or less than 70dB(A).
- Indoor and household use only.
- Disconnect the drive from the power supply or switch off the automatic controls when maintenance, such as window cleaning, is being carried out in the vicinity.
- When operating a biased switch, make sure that other persons are kept away.
- Do not operate when maintenance, such as window cleaning, is being carried out in the vicinity.
- The tube motor must only be supplied with safety extra low voltage corresponding to the marking on the appliance.
- This appliance contains batteries that are non-replaceable.

Important Installation instructions

WARNING: Important safety instructions. Follow all instructions, since incorrect installation can lead to severe injury.

- This motor can only be used with soft material for driven parts.
- Hazardous unprotected moving parts of the drive must be installed higher than 2.5m above the floor or any other level surface that could provide access to it.
- Install the actuating member of a manual release at a height less than 1.8m.
- The actuating member of a biased switch is to be located within direct sight of the driven part but away from moving parts. It is to be installed at a minimum height of 1.5m and not accessible to the public.
- The mass and the dimension of the driven part must be compatible with the rated torque and rated operating time.
- Fixed controls have to be clearly visible after installation.
- The driven part must be compatible with the rated torque (CM-05 2.0N.m) and rated operating time (12min).
- Minimum tube diameter: $\varnothing 28\text{mm}$.
- The drive is intended to be installed at a height of at least 2.5m above the floor or any other accessible level surface.
- All-pole disconnection switches must be incorporated in the fixed wiring in accordance with the wiring rules.
- The appliance must only be supplied at safety extra low voltage corresponding to the marking on the appliance.
- Before installing the drive, remove any unnecessary cords or components and disable any equipment not needed for powered operation.
- The battery must be removed from the appliance before it is scrapped. The appliance must be disconnected from the supply mains when removing the battery. The battery is to be disposed of safely.

FCC Manual | FCC ID: ZY4CM05

Regulatory Information

1 FCC Information for User

This product does not contain any user serviceable components and is to be used with approved antennas only. Any product changes or modifications will invalidate all applicable regulatory certifications and approvals.

2 FCC Electronic Emission Notices

This device complies with part 15 of the FCC Rules.

Operation is subject to the following two conditions:

1. This device may not cause harmful interference
2. This device must accept any interference received, including interference that may cause undesired operation.

3 FCC Radio Frequency Interference statement

This equipment has been tested and found to comply with the limits for a class B digital device, pursuant to Part 15 of the FCC Rules. These limits are designed to provide reasonable protection against harmful interference when the equipment is operated in a commercial environment. This equipment generates, uses and can radiate radio frequency energy and, if not installed and used in accordance with the instructions, may cause harmful interference to radio communications.







Operation of this equipment in a residential area may cause harmful interference, in which case the user will be required to correct the interference at their own expense.







If this equipment does cause harmful interference to radio or television reception, which can be determined by turning the equipment off and on, the user is encouraged to try to correct the interference by one or more of the following measures:

- Reorient or relocate the receiving antenna
- Increase the distance separating the equipment and receiver
- Connect the equipment to an outlet on a circuit different from that to which the receiver is connected
- Consult the dealer or an experienced radio/TV technician for help

EU Declaration

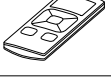
Hereby, Coulisse declares that the radio equipment type CM-05 is in compliance with directive 2014/53/EU. The full text of the EU declaration of conformity is available at the following internet address: www.my.coulisse.com

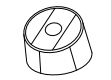
Motor	Application	Description	Motor diameter	Tube compatibility	Torque	Speed	Battery Capacity	Power supply	Input	Cable free	Speed control	Working temperature	Frequency emission power	Certificates
CM-05		Tubular motor	28 mm	42-50-65mm	2.0 Nm	28 rpm	2600mAh 31Wh (12V)					-10°C-50°C	≤2.32dBm	

	Channels	Wall mount	Program blinds	Single select	Channel select	Max. blinds	Max. scenes	Frequency	Range	Power supply	Length	Width	Height	Certificates
	1	■	■	-	-	unlimited	n/a	433.925 MHz	30 m with 1 concrete wall	CR2430 3.0V	120 mm	45 mm	14 mm	CE
	5	■	■	■	■	unlimited	n/a	433.925 MHz	30 m with 1 concrete wall	CR2430 3.0V	120 mm	45 mm	14 mm	CE
	15	■	■	■	■	unlimited	n/a	433.925 MHz	30 m with 1 concrete wall	CR2430 3.0V	120 mm	45 mm	14 mm	CE
	1	■	■	-	-	unlimited	n/a	433.925 MHz	30 m with 1 concrete wall	CR2430 3.0V	66 mm	32,5 mm	13,8 mm	CE
	4	■	-	-	-	unlimited	n/a	433.925 MHz	30 m with 1 concrete wall	3 x CR2430 3.0V	86 mm	86 mm	17 mm	CE
	4	-	■	-	-	unlimited	n/a	433.925 MHz	30 m with 1 concrete wall	2 x CR2450 3.0V	70,3 mm	62,7 mm	52,3 mm	CE
	1	-	-	-	-	unlimited	n/a	433.925 MHz	20 m open space	2 x LR44 1.5V	19,5 mm ø		69,9 mm	CE
	n/a	■	■	-	-	30	20	433.925 MHz Wi-Fi 2.4 GHz	30 m with 1 concrete wall	Micro USB - 5V DC	100 mm ø		25 mm	CE

CM-11
1 Channel Remote

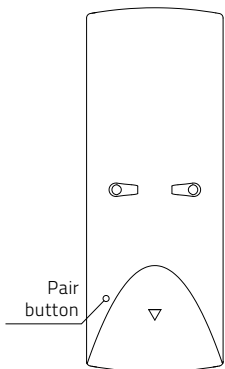
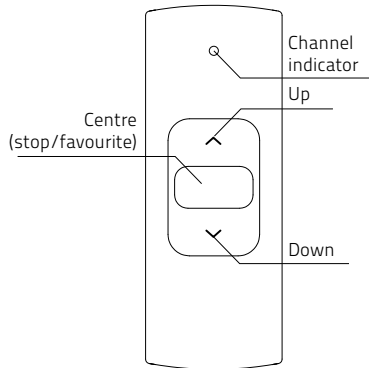
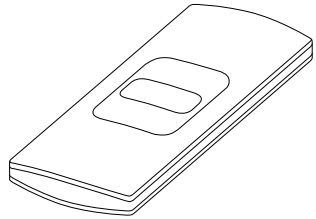

CM-12
5 Channel Remote

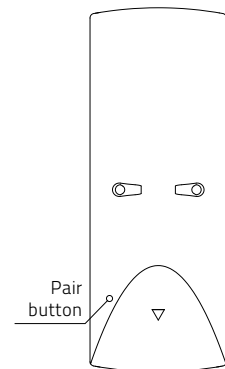
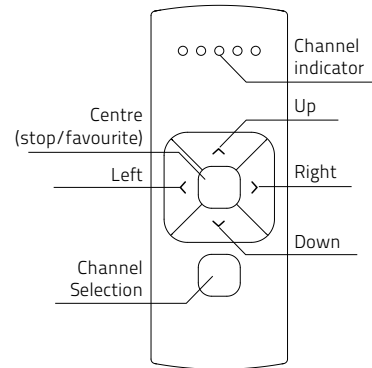
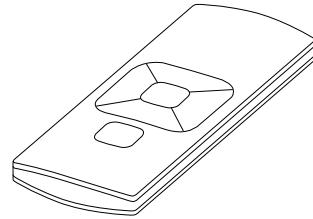

CM-13
15 Channel Remote

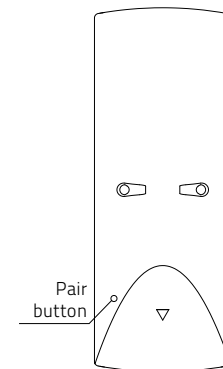
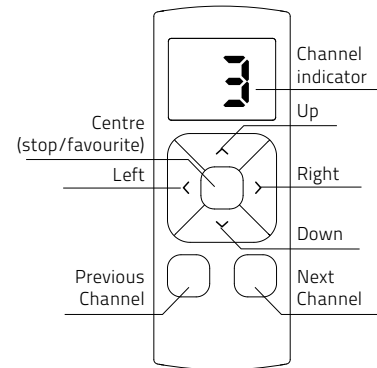
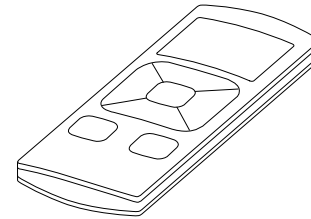

CM-17
4 Channel Table Remote

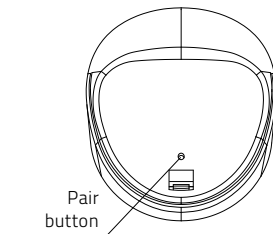
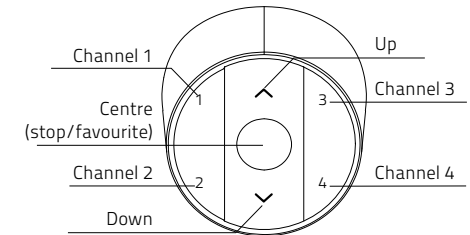
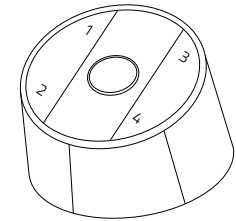

CM-15

1 Channel Wall Remote

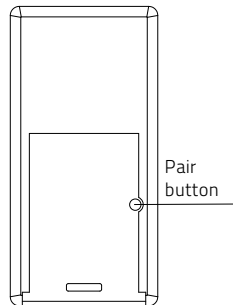
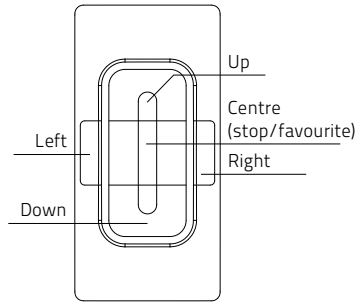
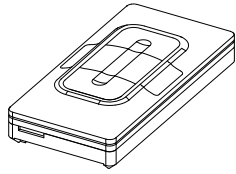

CM-16

4 Channel Wall Remote

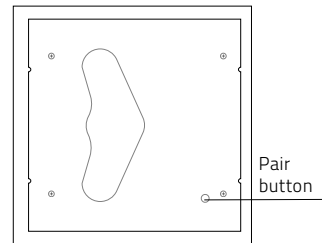
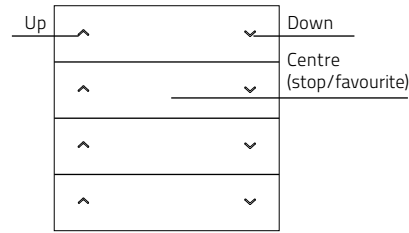
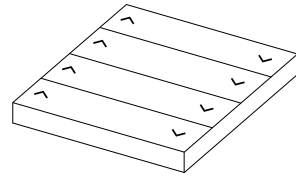

CM-18

1 Channel Tassel Remote

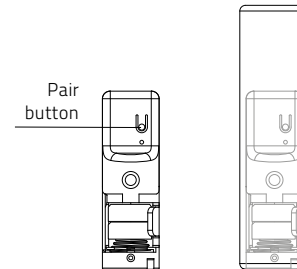

CM-20

Motion Bridge

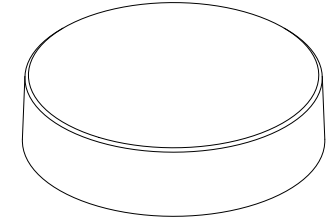

See manual CM-20

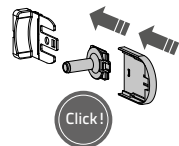
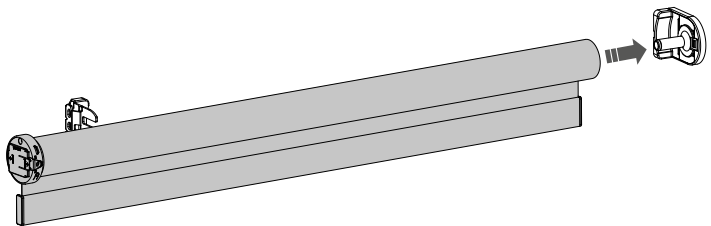
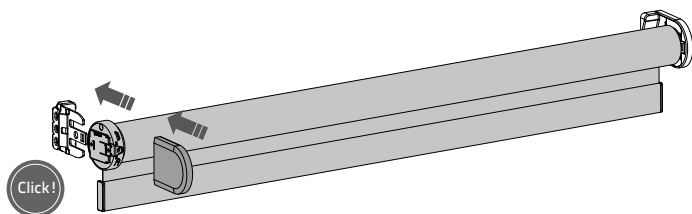
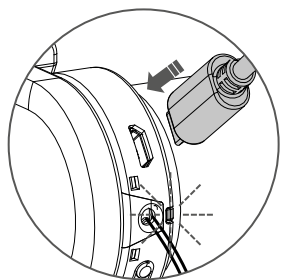
1 Install the blind**2****3****4****5** Activate the motor

Activate the motor by charging it with a micro USB cable. A green LED will start flashing. The motor can be used during charging. (To activate the motor without a micro USB cable, see step 25)

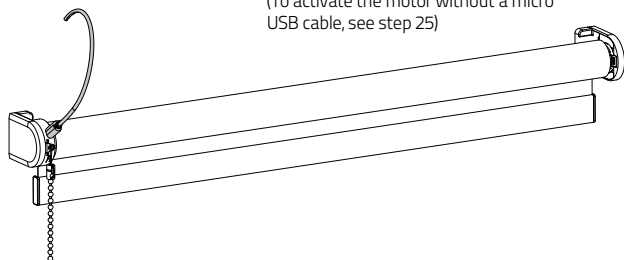
**6** Pair a remote

i Pair a remote control that is able to program blinds. See pages 4 and 5 for remote control details. In this manual, CM-12 is displayed.

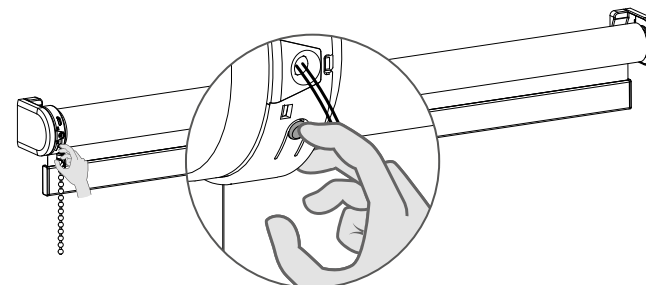

6.1 Shortly press the **program** button on the motor. The blind will start stepping, indicating that program mode has been activated. (The blind keeps stepping until the program mode is deactivated.)

6.2 Select a desired channel for the blind using the **channel selection** button on the remote control.

6.3 Press the **pair** button on the back of the remote control to pair the blind with the selected channel. The blind will shortly stop stepping, indicating that the remote has been paired to the blind.

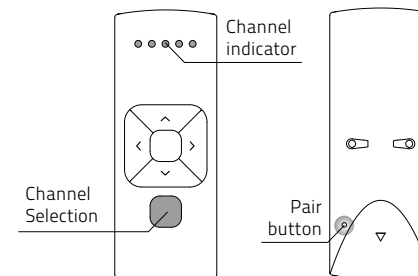

i Repeat steps 6.1 - 6.3 to remove a blind from a channel.

i End limits must be programmed to use a blind properly and to prevent it from being damaged. Proceed to step 12 if end limits are already set.

7 Check rotational direction

WARNING: risk of damage. Stop the blind before reaching the end positions.

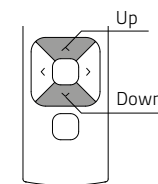
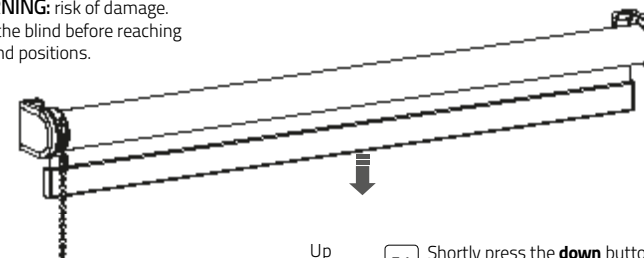

7.1 Shortly press the **down** button to check if the blind unrolls the right way. If the blind moves up, the rotational direction must be changed.

7.2 Simultaneously press the **up** and **down** button to change the rotational direction.